

# Operating Instructions

INTEGRATED  
TELEPHONE SYSTEM

MODEL NO. **KX-T2365A**

**EASA-PHONE**  
Telephone with Automatic Dialer  
and Speakerphone

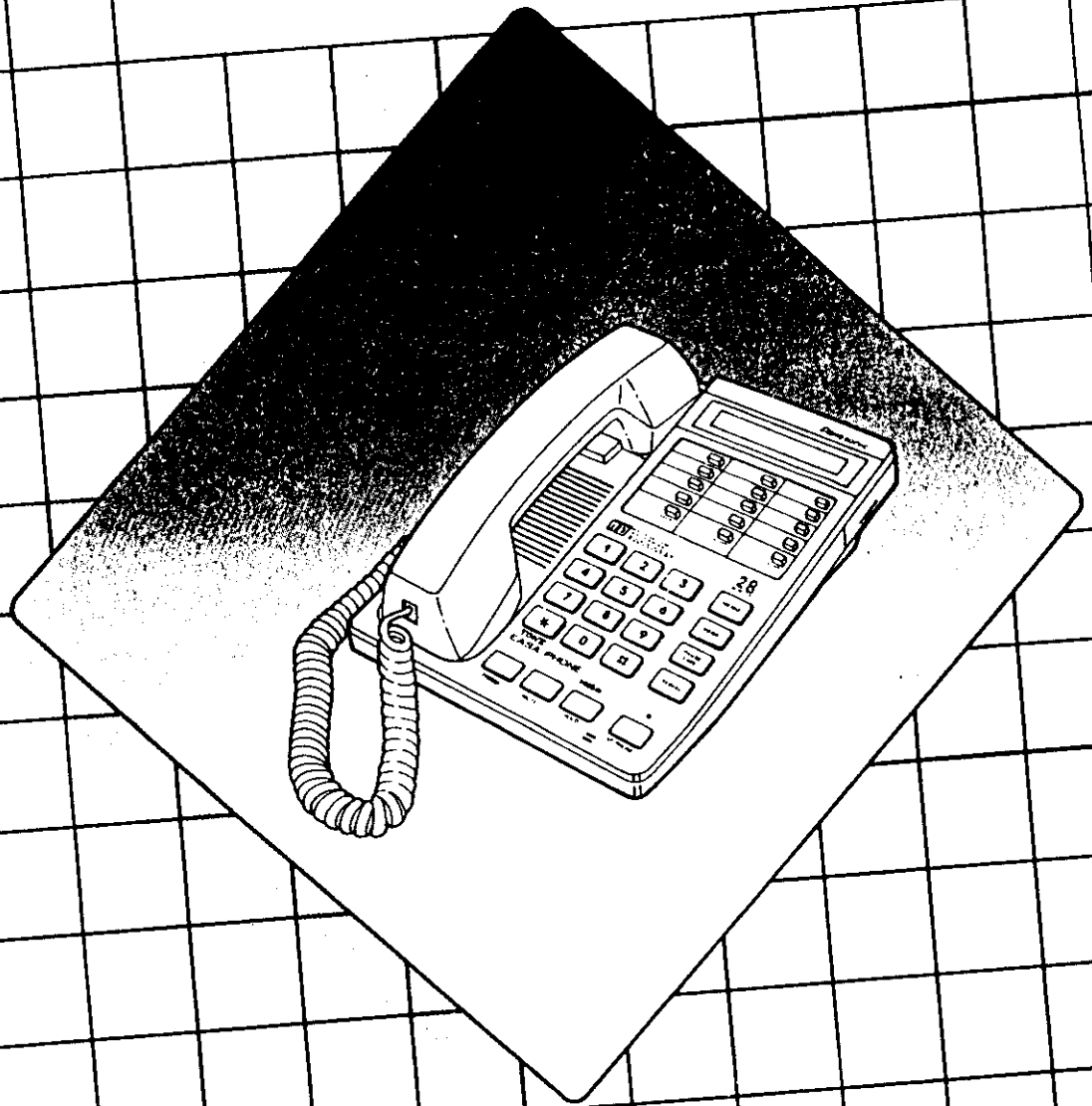

**Panasonic**

Please read before use.

# Contents

---

Location of Controls .....	2
Preparation .....	3
Manual Dialing and Receiving .....	4
Automatic Dialing .....	5
Storing and Dialing .....	6
Hold .....	9
Hands-free .....	9
Use of Other Features .....	10
Adjusting Time .....	11
Liquid Crystal Display .....	12
Battery Installation .....	13
Wall Mounting .....	14
Troubleshooting Guide .....	15
Others .....	16

## Enclosures

AA size batteries .....	3
Hardware .....	1 pack

# Location of Controls

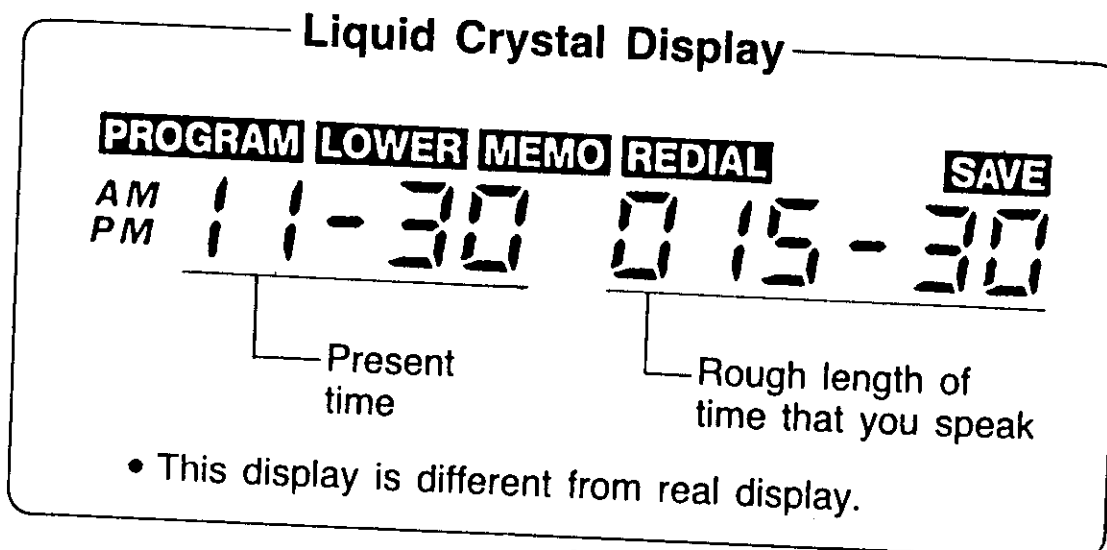
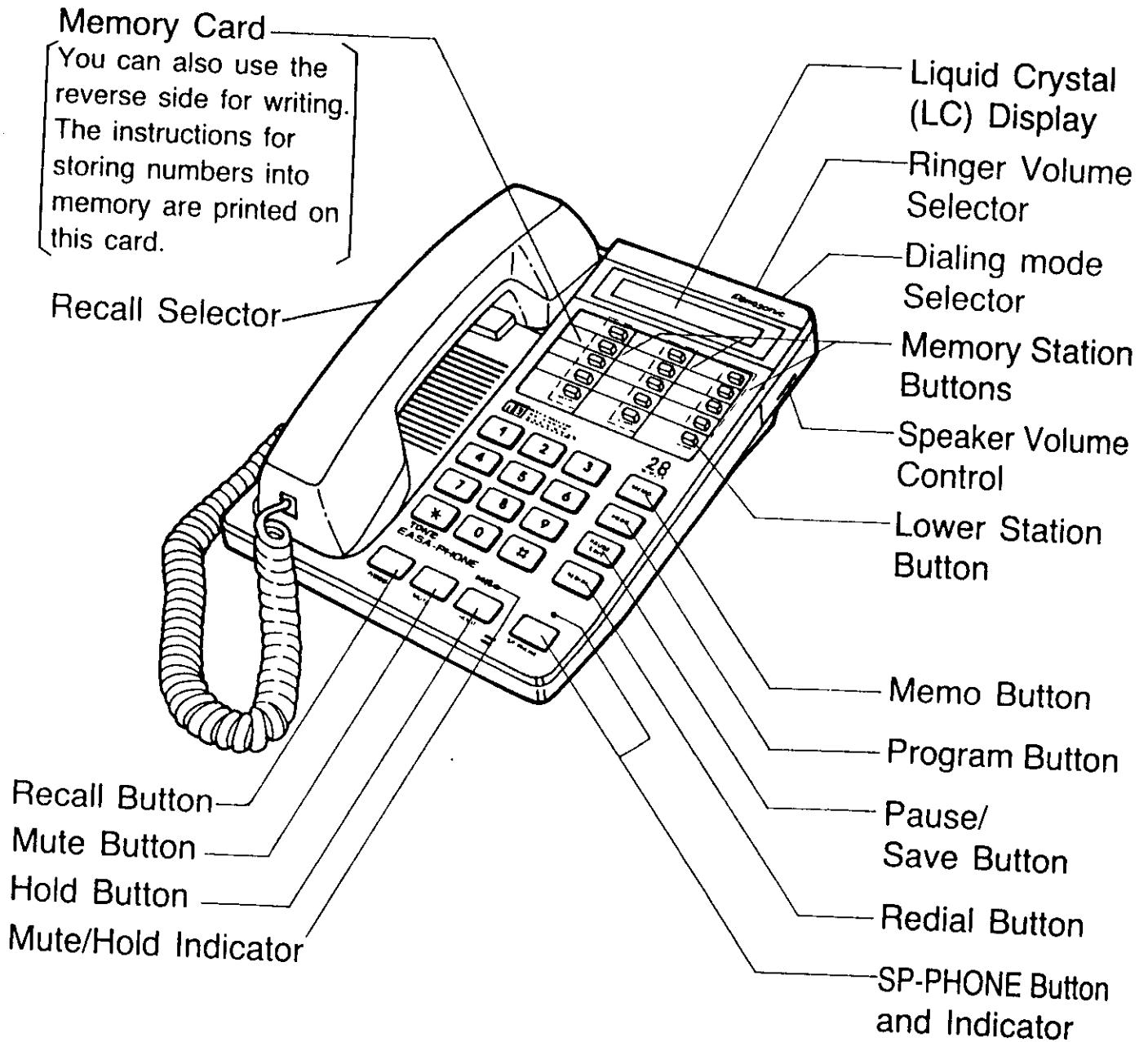

# Preparation

Connect as shown.

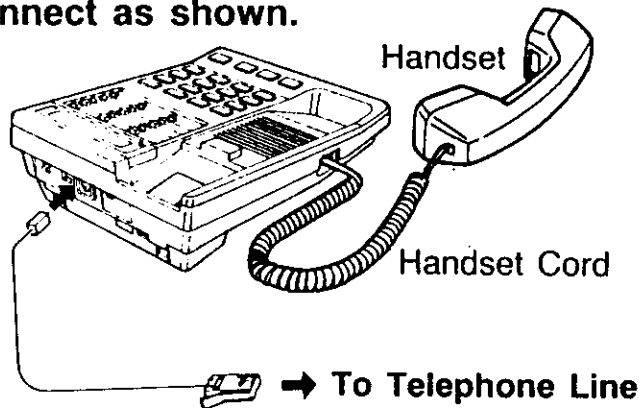

■ Do not use any handset other than Panasonic handset made for the model KX-T2365A.

**1 Ringer Volume Selector:**

Set to "HIGH".

LOW: The ringing sound level will be low.

OFF: The telephone will not ring.

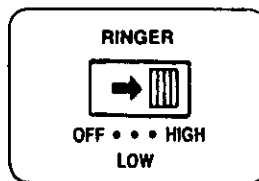

**2 Dialing Mode Selector:**

Set to "TONE".

If dialing cannot be done, set to "PULSE".

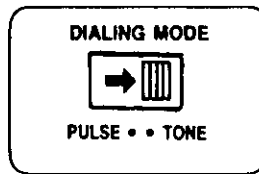

**3 Recall Selector:**

Set to "E RE" or "T BR".

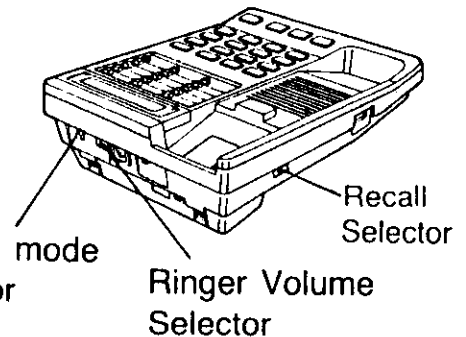
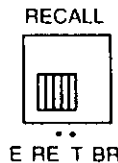

(depending on PBX type)

E RE ... for PBX earth recall facility

T BR ... for PBX timed break register recall facility

**4 Insert the batteries (included) in the proper order as indicated.**

For further details, see page 13.

**5 Select the LC Displays' contrast.**

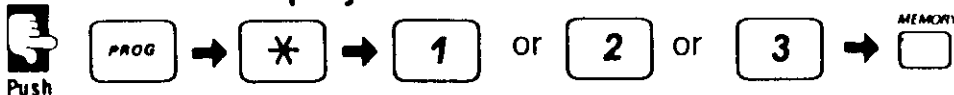

to choose the best display intensity.

1 : Low intensity

2 : Middle intensity

3 : High intensity

• Push the Program Button until the LC Display shows "PROGRAM"

PROGRAM

**6 Adjust the time.**

The LC Display will blink when first powered on. For further details, see page 11.

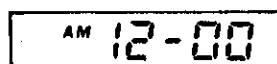

Replace all the batteries every 10 months, or misoperation may occur.

If the batteries are not installed, programming, and speakerphone operation can not be done.



Do not use rechargeable (Nickel-Cadmium) batteries.

# Manual Dialing and Receiving

When the unit is unused, the Liquid Crystal Display will show the present time only.

## Using the Handset

### Dialing

1 Lift the handset  and identify the dialing tone, then  the phone numbers to be dialed.

- The LC Display will show the phone number in order of pushing the Dialing button.

2 When the other party answers, start talking.  
• The LC Display will show the present time and the length of time that you speak.

3 When your call is finished, hang up the .



### Receiving

Lift the  and talk.

- The LC Display will show the present time and the length of time that you speak.

## Hands-free

### Dialing

1   and identify the dialing tone, then  the phone numbers to be dialed.

2 When your call is finished,



### Receiving

  and talk.

- The LC Display will show the same as "Using the Handset".
- If the batteries are not installed, speakerphone operation cannot be done.

## Redialing

If busy,  .

- The LC Display will show " **REDIAL** " and the redialed number. Also it will show the present time and the length of time that you speak.

- When using the handset; Depressing the Redial button enables you to redial once.

If the Mute/Hold Indicator lights when speaking, push .

# Automatic Dialing

Each Memory button consists of two functions, they are upper and lower memory locations. Each location (Upper+Lower) is capable of storing 16 digits.

## Storing Phone Numbers

Be sure the handset is on the cradle, the SP-PHONE button is off and batteries are installed (See page 13).

1  until a beep is heard.

- The LC Display will show "PROGRAM"

2 ■ Home Use (into the upper)



■ Office Use (PBX) (into the lower)

Depressing the Lower Station button must be done first, then the LC Display will show "LOWER".

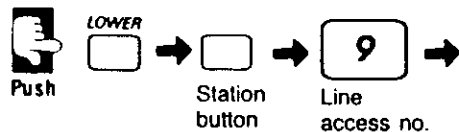

- The LC Display will show "SP" and the phone number.

3 After storing all the numbers,



- The LC Display will show the present time.
- To change a Stored Number, repeat above procedure.

## Dialing

### Using the Handset

1 Lift the  and identify the dialing tone.

2 ■ In using the upper station,  .

- The LC Display will show the phone number.

■ In using the lower station,  .

- The LC Display will show "LOWER" and the phone number.

3 When you finish, hang up the .

### Hands-free

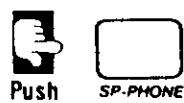
1  and identify the dialing tone.

2 ■ In using the upper station,  .

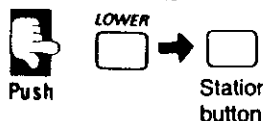
■ In using the lower station,  .

3 When you finish,  .

- The LC Display will show the same as "Using the Handset"

- Even while programming numbers, you can answer a call by simply lifting the handset. Programming is cancelled and then reprogramming shall be done.

# Storing and Dialing

- When using the lower station, depressing the Lower Station button must be done first.

## Correcting an Error while Storing

If you notice an error before pushing the Memory button:

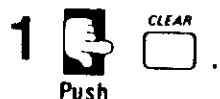

- The new entry is cleared and the previous storage remains untouched.

2 Repeat steps 2 of "Storing Phone Numbers" on page 5.

## Erasing a Stored Number

Be sure the handset is on the cradle and the SP-PHONE button is off.

Example:

To erase the number stored in the lower position of the memory station.

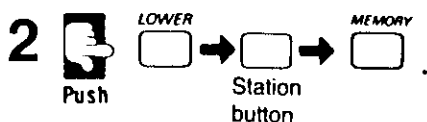

## Combination Dialing

Any combination dialing can be done.

- Automatic and Manual Dialing
- Pulse and Tone Dialing
- Plural Memory Stations

## Pause Usage

The Pause button function is needed for an outside line access number or a computer accessed line.

- Especially in manual dialing, a pause is required for the redialing.

To wait for a dial tone (PBX)



One pause is required

To wait for a computer tone

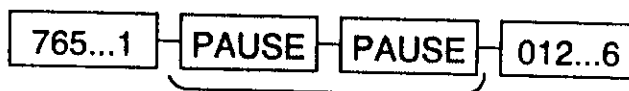

Two pauses are required

## Mute Operation

Use when you do not want your voice to be heard by the other party.



- The Mute/Hold Indicator will light.

2 To resume the conversation,



# Storing and Dialing (cont.)

## Saved Number Redial

The last dialed number can be stored into the Save button before hanging up (e.g. ... during a conversation).

This number will be saved until another number is stored again, and can be redialed any time by pushing the Save button.



- This function is useful to store the phone number which you wish to redial after dialing another number.

### ■ Storing

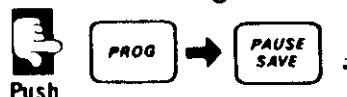
- 1  **Push**  to dial.
- 2 When the called line is busy or while having a conversation,



### ■ Dialing

- 1 Lift the  .  
or  
In hands-free mode;  **Push**  .
- 2  **Push**  .

## Storing during a Conversation (Memo Dial)

While having a conversation, another telephone number can be stored into the Memo button.

So you can dial this number by pushing the Memo button any time you like.

- This function is useful to store a telephone number, which is given to you by the other party.



### ■ Storing

- 1 While having a conversation,



- 2  **Push**  →  .

### ■ Dialing

- 1 Lift the  or  **Push**  .
- 2  **Push**  .

- If you store the new number into the Memo button, the previously stored number will be erased.



# Storing and Dialing (cont.)





## Storing the Last Dialed Number (Redial Memory Transfer) and Storing Memo Dialed Number (Memo Dial Transfer)

The last number manually dialed can be stored into a memory station.

**Example:** To store into the upper station.

Be sure the handset is on the cradle, and the SP-PHONE button is off.

### ■ Redial Memory Transfer

- 1  Push
- 2  Push →  → 

- The LC Display will show the redialed number.

- 3  Push

- Up to 30 digits will be dialed when using the redial function. When storing the last dialed number into memory, the maximum amount of digits can not exceed 16 digits.

### ■ Memo Dial Transfer

The Memo dial number can be stored into a memory station. Follow the procedure of "Redial Memory Transfer" and push the Memo button instead of the Redial button.

## Tone Button Usage

If you want to change from pulse mode into tone mode during dialing, the Tone ( ) button can be used instead of changing the Dialing Mode selector.

When you hang up, the dialing mode will be automatically returned to pulse mode.

## Recall Button

To access an outside line using the PBX recall facility, press the Recall Button. Depending on type of switching equipment to which Easa-Phone is connected, various functions, such as transfer, recall and hold can be initiated.

# Hold

## To Place a Call on Hold

While having a conversation,



- The Hold Indicator will blink slowly.
- You may hang up the .

## To Release Hold

- 1 ■ When the handset is being lifted:

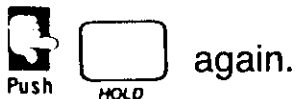

- When the handset is on the cradle;

- In using the handset

Lift the .

or

- In hands-free mode



- 2 Start talking.

# Hands-free

## Switching to Hands-free or Handset during a Conversation

You may choose to use the handset or hands-free.

### Hands-free → Handset

Switch to

Lift the .

- The SP-PHONE Indicator will go out.

### Handset → Hands-free

Switch to



- The SP-PHONE Indicator will light.

- 2 Hang up the .

- Before hanging up, you must push the SP-PHONE button.

## Helpful Hints for Hands-free

- If the other party finds it difficult to hear your voice:  
Lower the sound level using the Volume Control or speak louder.
- Absorbing echoes  
Use in a room that has curtains or carpeting.
- Effective Talking  
If some part of conversation is lost while talking, speak alternately.

# Use of Other Features

You may store a secret phone number and Hyphen.

So the secret phone number will not be seen on the LC Display when dialing.

**Example:**

Phone number 123-4567 into the upper station and 4567 is the secret number.

## Storage

Be sure the handset is on the cradle and the SP-PHONE button is off.



- The LC Display will show

" PROGRAM  
----- "

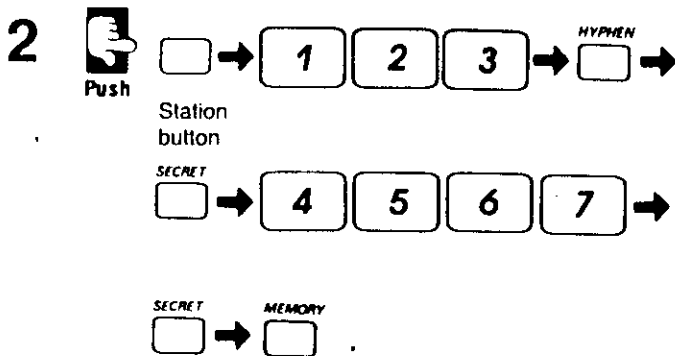

- The LC Display will show "123-[4567]" .
- If you need not Hyphen, do not push

the  button at step 2.

The LC Display will show

"123[4567]" .



- Pushing the HYPHEN button once counts as 2 digits.
- Pushing the SECRET button once counts as 2 digits.

## Automatic Dialing

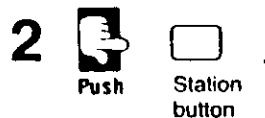

- The LC Display will show " 123-  
[0000]" .

The last four digits will not be shown.

- If you do not store a hyphen, the LC Display will show "123[0000]" .

# Adjusting Time

Be sure the handset is on the cradle and the SP-PHONE button is off.

## To Adjust

■ Example: To adjust the LC Display to 8:15 AM

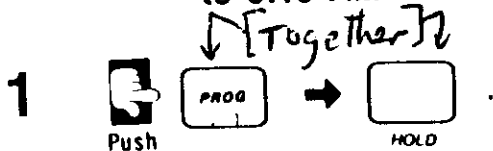

• The LC Display will show "^^00-00".

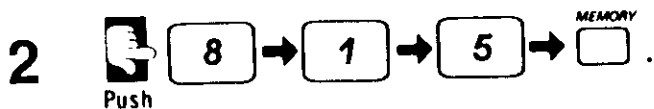

• The LC Display will show "^^08-15".

3 After adjusting the time, push the "MEMORY" button within 60 seconds from pushing the last button.

■ Other example: To adjust the LC Display to 9:05 PM

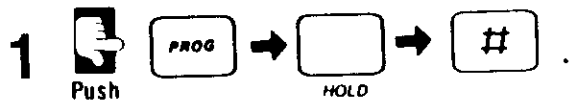

• The LC Display will show "--00-00".

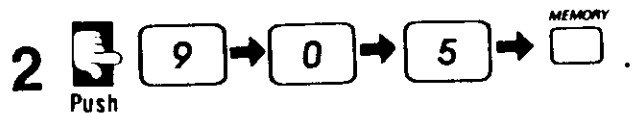

• The LC Display will show "--09-05".

■ When you push [#], the "PM" mode is entered.

If you push [#] once more, the "AM" mode is entered.

■ The MEMORY button must be pushed according to the time signal to set the seconds.

## Correcting an Error while Adjusting

If an error is found during adjustment, push the Dialing button from the beginning of the 4-digit to correct the time.

**Example:**

Time on the LC Display is 10:49 AM but correct time is 6:30 AM.

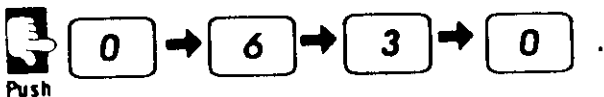

• The LC Display will show "^^06-30".

■ If your adjusted time is not valid (Ex. 19-65); When you push the "MEMORY" button, the mode will return to "PROGRAM".

The accuracy of the clock will be approximately  $\pm 40$  seconds a month at 0°C to 40°C of room temperature.

# Liquid Crystal Display

DISPLAY TYPE	WHEN THE DISPLAY SHOWS
" AM 12-00 " is flashing.	When you do not adjust the time.
AM 11-30	When the unit is not in use. • " AM 11-30 " indicates the present time.
AM 00-00	When you push <input type="button" value="PROG"/> and <input type="button" value="HOLD"/> .
PM 09-22 0 15-30	While you are in conversation. • " 0 15-30 " indicates that the length of time that you speak is about 15 minutes 30 seconds.
PROGRAM -----	When you push <input type="button" value="PROG"/> .
<b>REDIAL</b>	When you redial a phone number using the redial feature.
<b>LOWER</b>	When you push <input type="button" value="LOWER"/> .
<b>SAVE</b>	When you redial a phone number using the Saved Number Redial feature.
<b>MEMO</b>	When you push <input type="button" value="PROG"/> , while having a conversation. When you dial a phone number using the Memo Dial feature.
*	When you push <input type="button" value="*"/> except for the clock adjusting mode.
#	When you push <input type="button" value="#"/> except for the clock adjusting mode.
AM	When you push <input type="button" value="#"/> during displaying "PM" while in the clock adjusting mode.
PM	When you push <input type="button" value="#"/> during displaying "AM" while in the clock adjusting mode.
F	When you push <input type="button" value="RECALL"/> during programming.
P	When you push <input type="button" value="PAUSE SAVE"/> .
[0000]	When you dial a secret phone number.

# Battery Installation

Three AA size batteries serve as the power source to retain the stored telephone numbers in memory and to show display on the Liquid Crystal Display.

## To install the batteries

1. Remove the attaching stand.

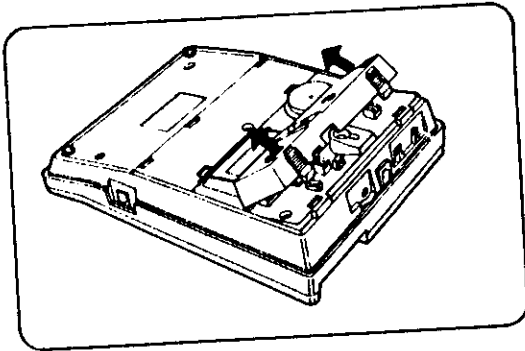

2.

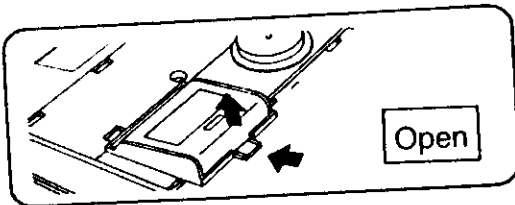

3. Insert the three AA size batteries observing the correct polarity.

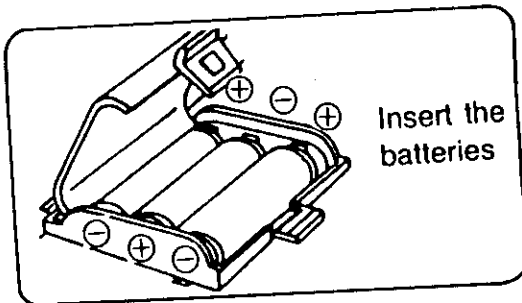

4. Replace the stand.

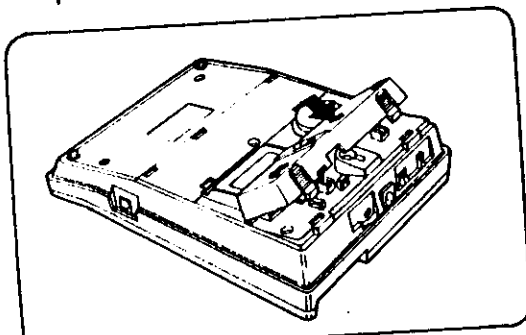

- Replace all the batteries every 10 months or misoperation may occur and Liquid Crystal Display will not show anything.
- To prevent loss of the stored telephone numbers, replace the batteries within 10 minutes after removing the old ones.
- Do not use rechargeable (nickel-cadmium) batteries. They are partially different in shape and performance may and fail to ensure proper function operation and may damage the unit.

## Battery Precautions

The batteries should be used correctly, otherwise, the unit may be damaged due to battery leakage.

- Do not mix different types of batteries.



- Do not charge, short-circuit, disassemble, heat or dispose in fire.



- Remove all batteries when replacing.



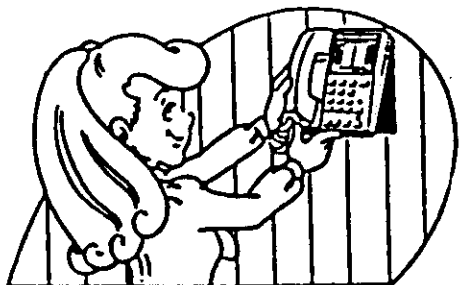

# Wall Mounting

This unit can be mounted on the wall utilizing the template and screws provided.

1. Turn over the handset guide.

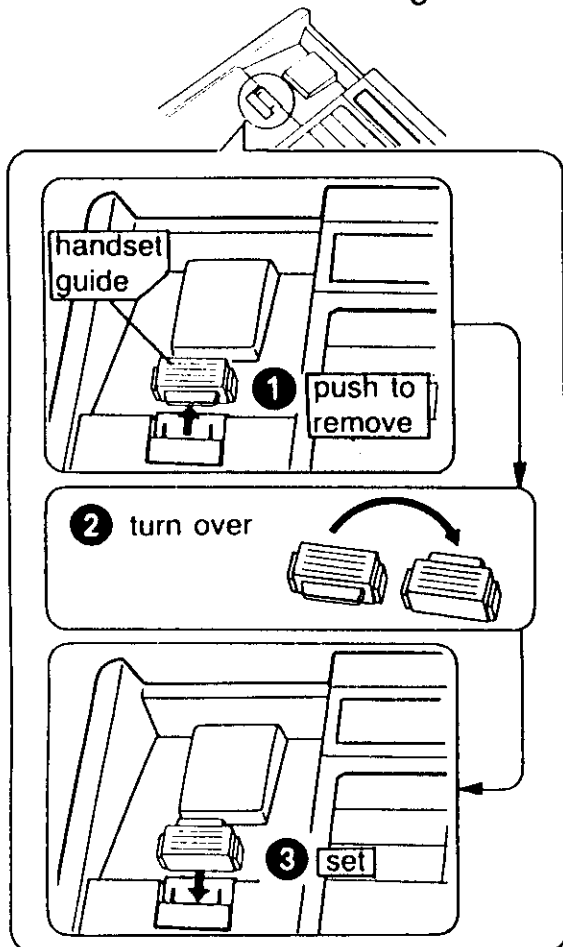

2. Remove the attaching stand.

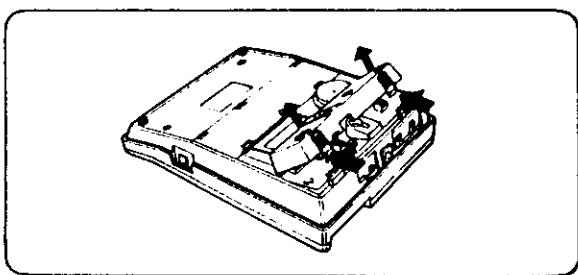

3. Replace the stand.

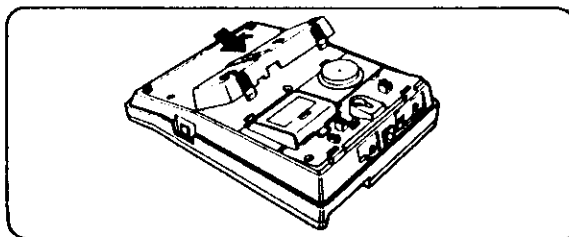

4. Place the template on the wall.

5. Using the washers fix the screws to the wall in the positions indicated.

6. Mount the unit on the wall so that the screw heads insert into the slots on the bottom, and then slide the unit down to hook it securely, as shown.

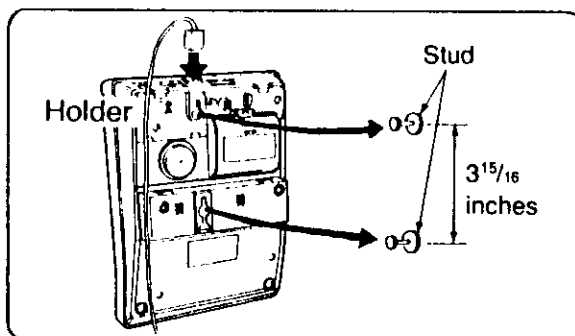

To temporarily place the handset down during a conversation, hook as shown.

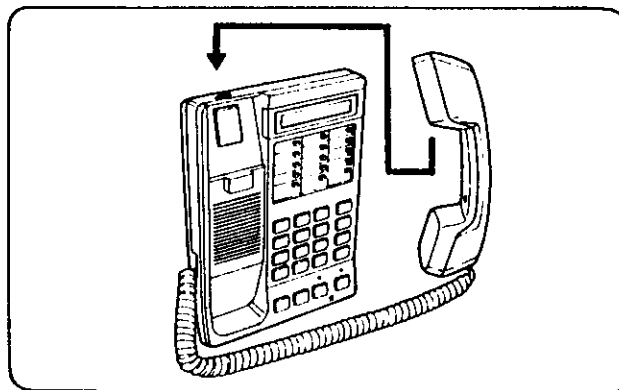

## Wall Template

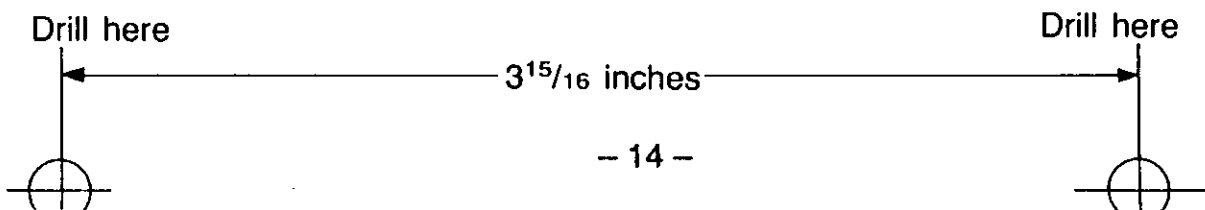

# Troubleshooting Guide

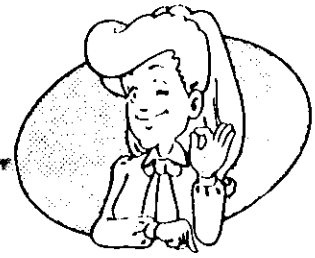

## Problem

## Cause & Remedy

The unit does not ring.

Ringer Volume Selector is set to "OFF". Set to "HIGH" or "LOW".

The caller suddenly cannot hear my voice during conversation.

Look at the Mute/Hold Indicator. If it lights, push the Mute button to resume the conversation.

I suddenly cannot hear the caller's voice during a conversation.

Look at the Mute/Hold Indicator. If it blinks slowly, push the Hold button to resume the conversation.

Redialing operation does not function.

The LC Display does not show "PROGRAM" when the Program button is pushed. (Program operation does not function.)

The unit does not keep stored memory.

The LC Display shows the wrong display or nothing.

Hands-free operation does not function after pushing the SP-PHONE button.

Batteries have become weak. Replace all the batteries.



# Others

---

- If there is any trouble, disconnect the unit from the telephone line and connect a known working telephone. If the known working telephone operates properly, return your unit to your supplier for repair, if the known working telephone does not operate properly, consult with a telephone company.
- When a Station button is pushed and nothing seems to operate, unplug the telephone cord then replace the batteries.
- Keep the unit away from heating appliances, and electrical noise generating devices such as fluorescent lamps and motors.
- The unit should be kept free of dust, moisture and vibration, and should not be exposed to direct sunlight.
- Do not use benzine, thinner, or the like, or any abrasive powder to clean the cabinet. Wipe it with a soft cloth.
- Do not use any handset other than Panasonic handset made for the model KX-T2365A.

**WARNING:**

TO PREVENT FIRE OR SHOCK HAZARD, DO NOT EXPOSE THIS PRODUCT TO RAIN OR ANY TYPE OF MOISTURE.